

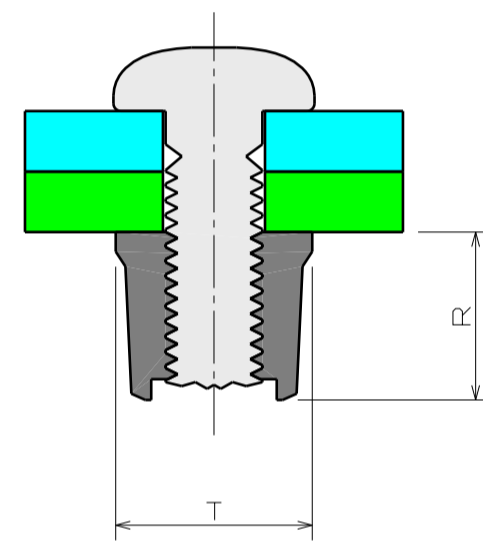

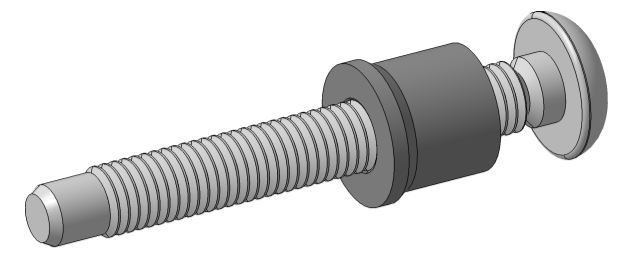

BEFORE PLACING

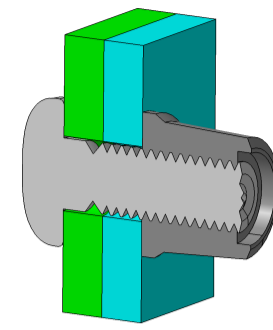
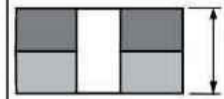

AFTER PLACING

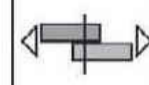
ø				B	D	F	R	T			Part No/ref	
	nom.	min.									max.	max.
6.4 (1/4")	1.6	15.9	6.75	13.3	4.2	2.2	11.1	13.0	7.45	9.79	01921-00810	01985-00800
	7.9	31.7				9.1					01921-00820	